

# Carrinho para notebook

## Carrinho para notebook (Sem acessórios)

- Aplicações: prontuário eletrônico.
- Dimensões externas: (A) 945mm a 1215mm x (L) 590mm x (P) 590mm
- Estrutura: construído em alumínio, inox, aço galvanizado e polímero plástico (ABS).
- Mesa de apoio lateral para preparo de medicamentos.
- 1 gaveta com visor para identificação do paciente e trava.
- Possui 4 rodízios de 4 polegadas : 2 com freio e 2 sem freios.
- Suporte com ajuste de altura para notebook e local para armazenamento do carregador. Possui trava para ambos através de chave.
- Suporte para leitor de código de barras.



### Dimensões Técnicas

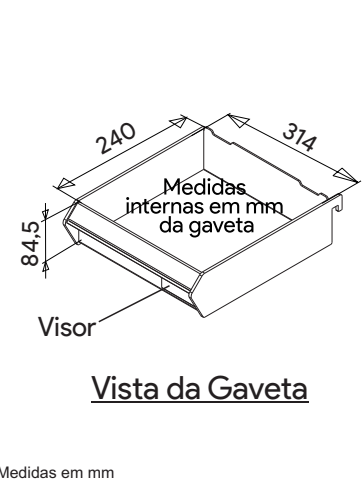

### Vista Frontal

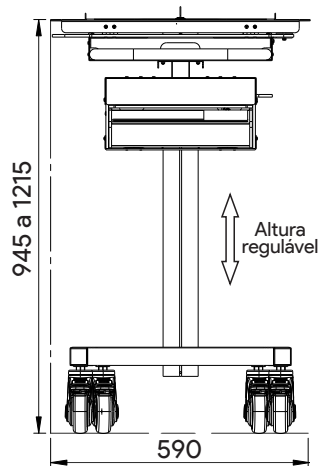

### Vista Superior

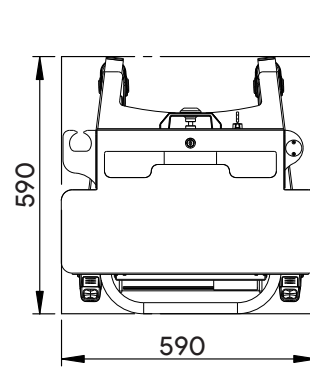

### Vista Lateral

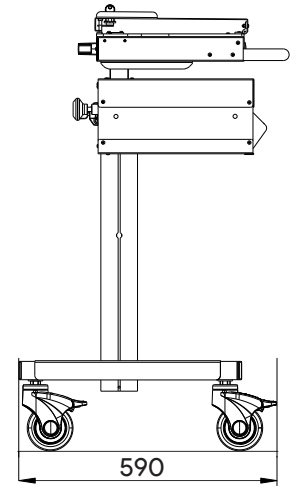

### Adicione acessórios:



Suporte para soro e álcool em gel



Suporte + Lixeira com pedal

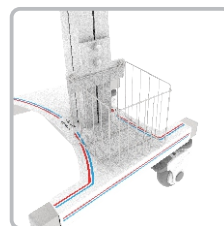

Suporte para caixa de perfuro cortante de 3L

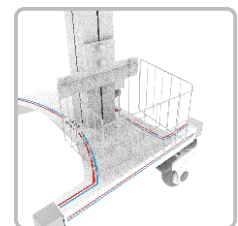

Suporte para caixa de perfuro cortante de 7L



Suporte para Monitor / Desktop

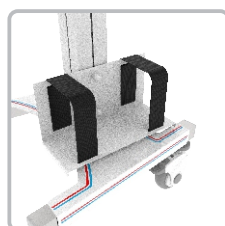

Suporte para nobreak

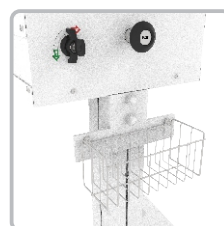

Suporte para materiais diversos

Acessórios especiais, sob consulta

# Carrinho para notebook



# Instruções para Regulagem de altura manual



1 - Puxe a alavanca e segure

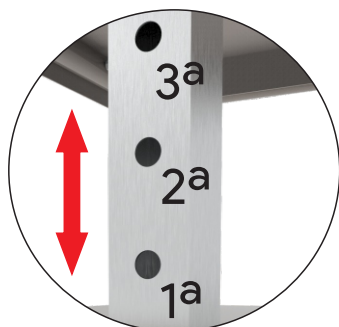

2 - Ajuste a posição de altura



3 - Solte a alavanca

